

Office-A
ambientes corporativos



CADEIRAS PROFISSIONAIS

CATÁLOGO 2020



Em qualquer ambiente, seja na empresa ou home office, a melhor parceria para o seu conforto e bem-estar.

A Office A é uma empresa que aplica excelência e eficiência em tudo o que faz, em um esforço constante para satisfazer as necessidades dos seus clientes, sempre encontrando a melhor solução para os seus objetivos.

A Cavaletti - Cadeiras Profissionais é conhecida nacional e internacionalmente por possuir um mix de produtos consolidado e em constante evolução, em que cada linha se destaca pela sua aplicação, facilitando o trabalho de escolha e especificação.

Juntos, possuímos a melhor e mais completa linha de produtos com qualidade, inovação e pioneirismo, para encantar os mais diversos clientes, do mais simples ao mais sofisticado, em qualquer ambiente que precisar, tanto na empresa quanto no home office.



Office.A

ambientes corporativos

Produtos com 6 anos de garantia
(vide condições)

Revendedor exclusivo no
Polo Moveleiro de Belo Horizonte



CADEIRAS PROFISSIONAIS



Office-A
ambientes corporativos

REVENDEDOR
EXCLUSIVO

POLO MOVELEIRO
SILVANO BRANDÃO

Cavaletti

CADEIRAS PROFISSIONAIS

Cavaletti Slim

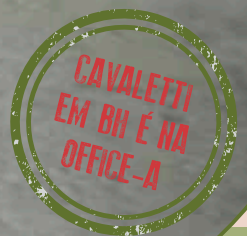

Cavaletti Slim

Com Design Original Cavaletti, a linha Slim possui encosto e assento com curvaturas anatômicas, mecanismo Sincron com quatro posições de travamento, opção de bases de aço ou alumínio e braços com movimentos 3D. Além de ser uma linha corporativa completa, seu desenho minimalista faz com que a Slim esteja pronta para integrar projetos mais contemporâneos.

CARACTERÍSTICAS



ACABAMENTOS

Diferentes opções de revestimento: Poliéster, Vinil, Space, CEC e Couro.



MECANISMOS

Mecanismo Synchron 2:1 com 4 opções de travamento, Sistema Reclinador de Encosto ou Relax.

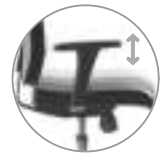

ASSENTO

Assento em espuma em alta performance com Regulagem de Altura à Gás.



BRAÇOS

Modelos giratórios com Braços Reguláveis SL, SL New PU ou 2D, todos com opção de Regulagem Lateral, ou 3D. Modelos fixos com braços integrados à estrutura.



BASES

Bases em Alumínio, Nylon, Estampada ou Aço com Capa. Rodízios em Nylon ou PU.



ESTRUTURA

Estrutura fixa com Braços Integrados nas opções Balanço (S), Z com Rodízios ou Z sem Rodízios. Acabamento Cromado ou Preto Ultrafosco Microtexturizado.



CONFIGURAÇÕES



18001
Presidente Giratória
Synchron
Braço SL
Base Alumínio



18002
Diretor Giratória
Synchron
Braço SL
Base Estampada



18004 SRE
Executiva Giratória
Sistema Reclinador de Encosto
Braço SL
Base Nylon



18006 Z ROD
Diretor Aproximação
Estrutura Z com Rodízios
Braços Integrados



18006 Z
Diretor Aproximação
Estrutura Z
Braços Integrados



18006 P
Diretor Aproximação
Estrutura P
Braços Integrados



18006 S
Diretor Aproximação
Estrutura S
Braços Integrados



18007 S
Secretária Aproximação
Estrutura S
Braços Integrados



18010
Diretor Longarina
Braço Z Intercaleado

DESENHOS TÉCNICOS

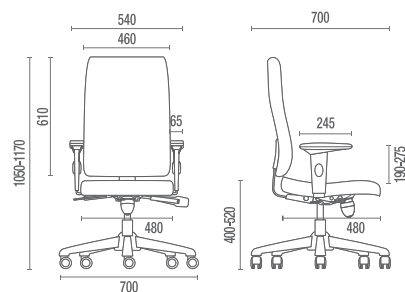

18001 Presidente Giratória

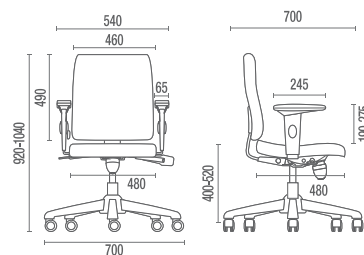

18002 Diretor Giratória

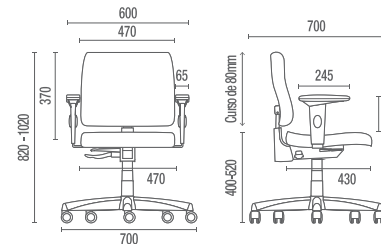

18004 SRE Executiva Giratória

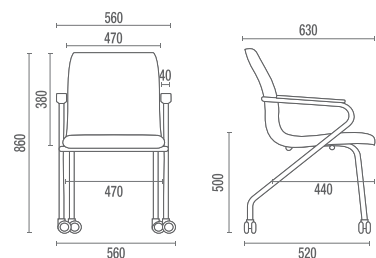

18006 Z ROD Aproximação Giratória

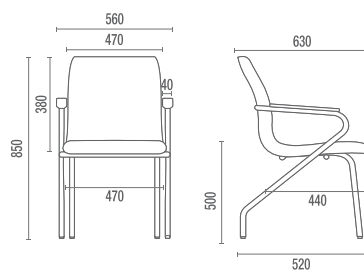

18006 Z Aproximação Fixa

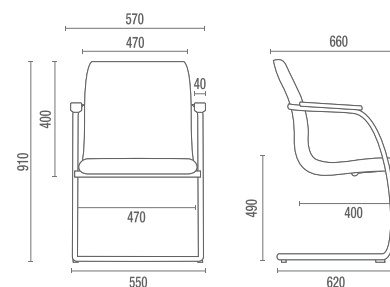

18006 S Diretor Aproximação

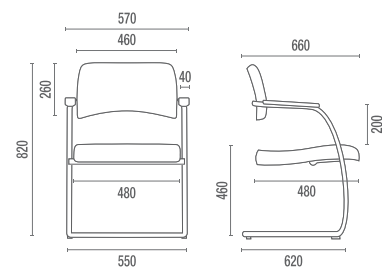

18007 S Secretária Aproximação

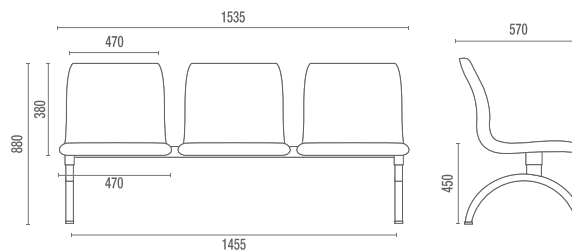

18010 Longarina
Larguras sem Braço: 2L – 1000mm
4L – 2070mm
5L – 2605mm
Larguras com Braço: 2L – 1080mm
4L – 2110mm
5L – 2625mm



Office-A
ambientes corporativos

REVENDEDOR
EXCLUSIVO

POLO MOVELEIRO
SILVIANO BRANDÃO



CADEIRAS PROFISSIONAIS



CAVALETTI
EM BH É NA
OFFICE-A

Cavaletti Start

Cavaletti Start

A linha Start oferece uma diversidade de modelos que se adaptam a diferentes ambientes. Com alta qualidade e acabamentos selecionados, os modelos Start são ergonômicos e buscam o conforto ideal para o dia-a-dia dos escritórios.

CARACTERÍSTICAS

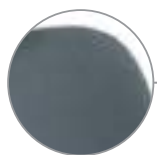

ACABAMENTOS

Diferentes opções de revestimento: Polipropileno, Poliéster, Vinil, CEC e Space.



MECANISMOS

Mecanismo Synchron com regulagem de altura do encosto ou Relax com opção de regulagem de encosto para os modelos Presidente e Diretor. Sistema de Reclinação do Encosto (SRE) com regulagem de altura do encosto para os modelos Executiva e Secretária.



ESPAIDAR

Espaldares em quatro alturas diferentes: Presidente, Diretor, Executiva e Secretária.



ASSENTO

Assento em espuma injetada com Regulagem de Altura à Gás.



BASES

Bases em Aço com Capa. Rodízios 50mm em Nylon ou PU.



BRAÇOS

Modelos giratórios com Braços Reguláveis SL, SL New PU ou 2D (todos com opção de Regulagem Lateral) ou 3D. Braços fixos nas opções Americano, Corsa ou Style.

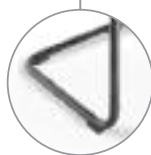

ESTRUTURAS

Estrutura fixa nas opções Arco (A), Palito (P) ou Balanço (S).

CONFIGURAÇÕES



4001
Presidente Giratória
Relax
Braço SL



4002
Diretor Giratória
Relax
Braço SL



4003
Diretor Giratória Extra
Relax
Braço SL com Regulagem Lateral



4006 S
Diretor Aproximação
Estrutura S
Braço Americano



4006 PUE
Diretor Universitária
Prancheta Escamoteável
Braço Americano



4103
Executiva Giratória
Sistema de Reclinação do Encosto
Braço SL New PU



4107 S
Executiva Aproximação
Estrutura S



4123
Executiva Caixa
Sistema de Reclinação do Encosto
Braço SL New PU



4004
Secretária Giratória
L2048 com Regulagem
Braço SL



4008 A
Secretária Aproximação
L2048 Fixo
Estrutura Arco



4022
Secretária Caixa
L2048 com Regulagem



L2048
Regulagem
de Altura
do Encosto
(4004 e 4022)



4005
Diretor Longarina
Braço americano



4110
Executiva Longarina



4005 U / 4110 U
Prancheta Escamoteável
Opcional para 4005 e 4110



4009
Secretária Longarina
L2048 fixo

DESENHOS TÉCNICOS

Office.A
ambientes corporativos

REVENDEDOR EXCLUSIVO
POLO MOVELEIRO
SILVIANO BRANDÃO

Cavaletti®
CADEIRAS PROFISSIONAIS

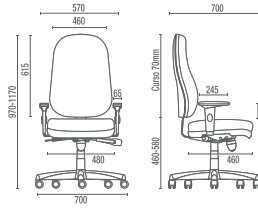

4001 Presidente Giratória

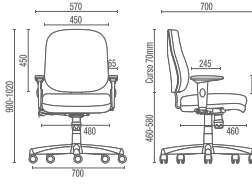

4002 Diretor Giratória

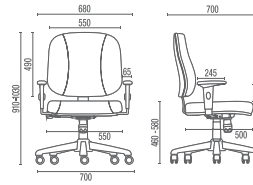

4003 Diretor Giratória Extra

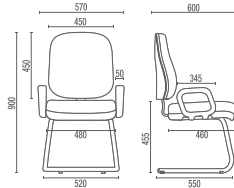

4006 S Diretor Aproximação

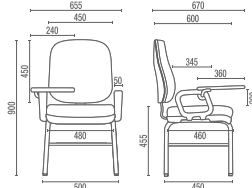

4006 PUE Diretor Universitária

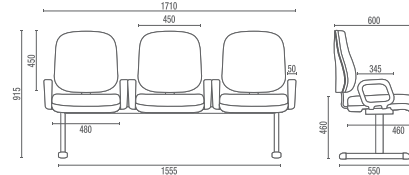

4005 Diretor Longarina
Larguras com Braço Duplo:
2L – 1140mm 3L – 1710mm 4L – 2280mm 5L – 2850mm

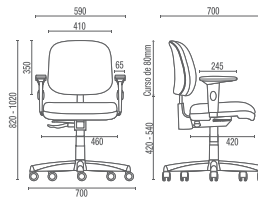

4103 SRE Executiva Giratória

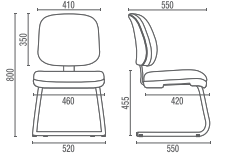

4107 S Executiva Aproximação

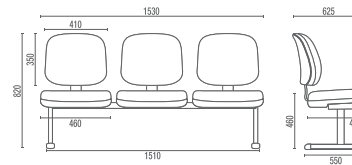

4110 Executiva Longarina

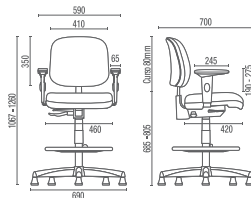

4123 SRE Executiva Caixa

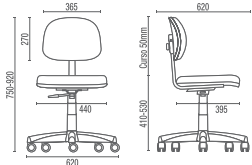

4004 Secretária Giratória

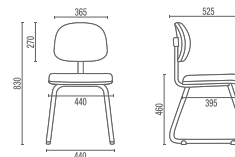

4008 A Secretária Aproximação

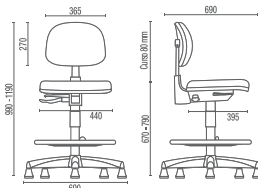

4022 SRE Secretária Caixa

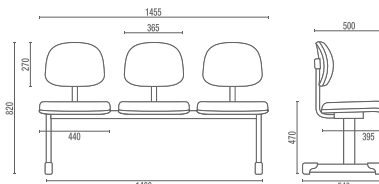

4009 Secretária Longarina





Office-A
ambientes corporativos

REVENDEDOR
EXCLUSIVO

POLO MOVELEIRO
SILVIANO BRANDÃO

Cavaletti[®]
CADEIRAS PROFISSIONAIS

Cavaletti Joy

CAVALETTI
EM BH É NA
OFFICE-A

Office-A
ambientes corporativos

REVENDEDOR
EXCLUSIVO

POLO MOVELEIRO
SILVIANO BRANDÃO

Cavaletti®
CADEIRAS PROFSSIONAIS



CARACTERÍSTICAS

Tem horas que tudo o que a gente precisa é descomplicar.

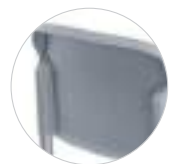

HANDLE
Design inteligente, permite praticidade no manuseio.



CLICKS
Sem parafusos. O sistema de montagem é todo por click.



PROTEÇÃO
Apoio para empilhamento com esperas em TPE.



EMPILHAMENTO
Empilhável até 10 unidades.

COMPOSIÇÕES



41.008
Branco Off
Plásticos Branco Off 44
Base Branco Off Ultrafosco
Opção de Base Cromada



41.008
Cinza
Plásticos Cinza 41
Base Prata Fosco
Opção de Base Cromada



41.008
Grafite
Plásticos Grafite 45
Base Grafite Ultrafosco
Opção de Base Cromada



41.008
Preto
Plásticos Cinza 41
Base Preto Ultrafosco
Opção de Base Cromada



41.008
Azul
Plásticos Azul Noite 32
Base Azul Ultrafosco
Opção de Base Cromada



41.008
Oliva
Plásticos Oliva 76
Base Oliva Ultrafosco
Opção de Base Cromada



41.008
Areia
Plásticos Areia 77
Base Areia Ultrafosco
Opção de Base Cromada



41.008
Telha
Plásticos Terracota 78
Base Telha Ultrafosco
Opção de Base Cromada



41.008
Amarelo
Plásticos Amarelo 16
Base Amarelo Ultrafosco
Opção de Base Cromada



41.008
Vermelho
Plásticos Vermelho Apple 43
Base Vermelho Ultrafosco
Opção de Base Cromada



Carrinho
Empilhamento máximo: 10 unidades

DESENHOS TÉCNICOS

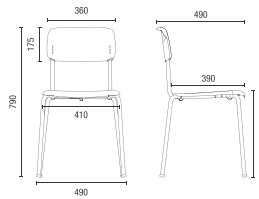

41.008 Aproximação

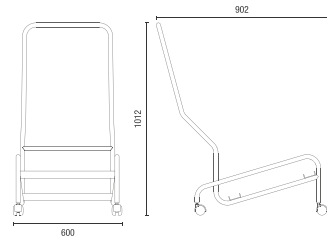

Carrinho
Empilhamento máximo: 10 unidades

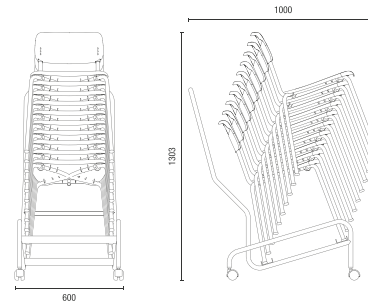

Carrinho
Empilhamento máximo: 10 unidades

ESTRUTURAS

	Preto Ultrafosco	Prata Fosco	Cromado	Grafite Fosco	Vermelho	Telha	Amarelo	Areia	Oliva	Azul	Branco Off
 Preto 06	●	●	●								
 Grafite 45	●	●	●	●							
 Vermelho Apple 43	●	●	●		●						
 Telha 78	●	●	●			●					
 Amarelo 16	●	●	●				●				
 Areia 77	●	●	●					●			
 Oliva 76	●	●	●						●		
 Azul Noite 32	●	●	●							●	
 Cinza 41	●	●	●								
 Branco Off 44	●	●	●								●

PLÁSTICOS

Office-A
ambientes corporativos

REVENDEDOR EXCLUSIVO
POLO MOVELEIRO SILVIANO BRANDÃO

Cavaletti®
CADEIRAS PROFISSIONAIS



Office-A
ambientes corporativos

REVENDEDOR
EXCLUSIVO

POLO MOVELEIRO
SILVIANO BRANDÃO

Cavaletti
CADEIRAS PROFISSIONAIS

Cavaletti NewNet

CAVALETTI
EM BH É NA
OFFICE-A

Cavaletti NewNet

A linha NewNet oferece a experiência única proporcionada pelo encosto em tela. Desenvolvido para adaptar-se continuamente à curvatura da coluna e oferecer maior apoio, este material também proporciona melhor ventilação natural quando em uso.

A NewNet Soft é resultado da união da tela de dupla membrana com a flexibilidade das cores e materiais de revestimento, unindo a ergonomia proporcionada pela tela à variedade de acabamentos de uma cadeira estofada, em design sofisticado e único.

Office-A
ambientes corporativos

REVENDEDOR
EXCLUSIVO

POLO MOVELEIRO
SILVIANO BRANDÃO

Cavaletti®
CADEIRAS PROFSSIONAIS



CARACTERÍSTICAS



ACESSÓRIOS

Opção de Apoio para a Cabeça disponível para os modelos 16001 e 16501.



MECANISMOS

Mecanismo Sincron, Sistema Reclinador de Encosto (SRE) ou Plataforma Giratória sem Relax conforme modelo.



REVESTIMENTOS

Diferentes opções de revestimento para assento NewNet ou assento e encosto NewNet Soft: Poliéster, Space e CEC.



ENCOSTO

Tela de dupla membrana (modelos 16000) com opção de revestimento para NewNet Soft (modelos 16500).



ASSENTO

Assento em espuma injetada com Regulagem de Altura à Gás.



BRAÇOS REGULÁVEIS

Modelos giratórios com braço SL, SL New PU, 2D ou 3D.



BASES

Bases em Alumínio, Nylon ou Estampada. Rodízios de 50 ou 60mm em Nylon ou PU.



ESTRUTURA

Estrutura fixa Balanço (S) com opções de acabamentos cromado e preto ultrafosco texturizado.



CONFIGURAÇÕES

NEWNET



16001 AC
Presidente Giratória
Sincron
Braço 3D
Base Alumínio



16001
Presidente Giratória
Sincron
Braço 3D
Base Estampada



16002
Diretor Giratória
Sincron
Braço 3D
Base Nylon



16003 SRE
Executiva Giratória
Sistema Reclinador de Encosto
Braço SL
Base Nylon



16006 S
Executiva Aproximação
Estrutura S
Braços Integrados



16010
Longarina Executiva
L2048 Fixo
Braço Loop Intercalado



16010
Longarina Executiva
L2048 Fixo

NEWNET SOFT



16501 AC
Presidente Giratória
Sincron
Braço 3D
Base Alumínio



16501
Presidente Giratória
Sincron
Braço 3D
Base Estampada



16503 SRE
Executiva Giratória
Sistema Reclinador de Encosto
Braço SL New PU
Base Estampada



16506 S
Executiva Aproximação
Estrutura S
Braços Integrados

DESENHOS TÉCNICOS

NEWNET

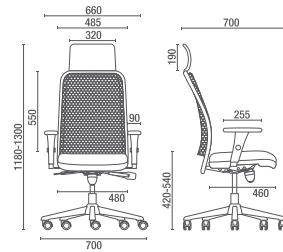

16001 AC Presidente Giratória

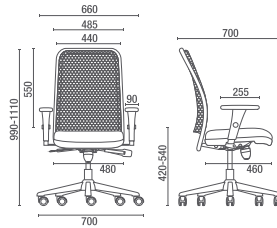

16001 Presidente Giratória

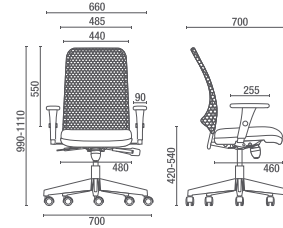

16002 Diretor Giratória

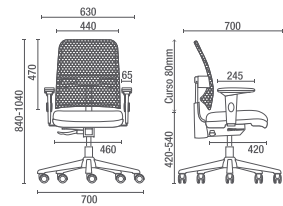

16003 SRE Executiva Giratória

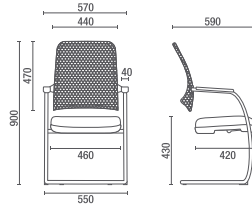

16006 S Executiva Aproximação

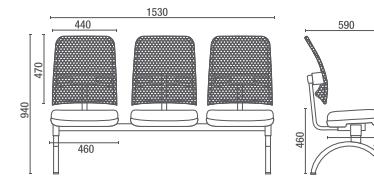

16010 Longarina Executiva

NEWNET SOFT

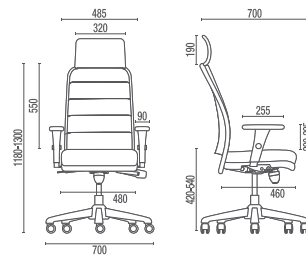

16501 AC Presidente Giratória

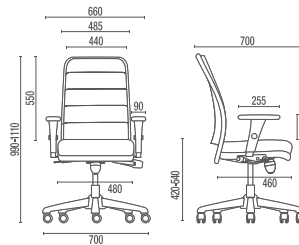

16501 Presidente Giratória

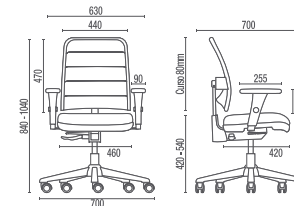

16503 SRE Executiva Giratória

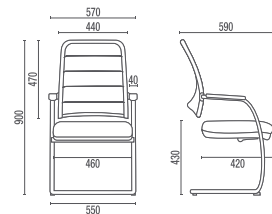

16506 S Executiva Aproximação



R4DESIGN

©Copyright 2014 Cavaletti S/A - Todos os direitos reservados. A Cavaletti S/A reserva-se o direito de alterar produtos a qualquer tempo e sem aviso prévio. Alguns itens são opcionais e podem não fazer parte do produto básico. SET/2014 V1 Tiragem 5.000.



Office-A
ambientes corporativos

REVENDEDOR
EXCLUSIVO

POLO MOVELEIRO
SILVIANO BRANDÃO

Cavaletti

CADEIRAS PROFISSIONAIS

05
COFFEE

03
MEET

Cavaletti Flip

CAVALETTI
EM BH É NA
OFFICE-A



Office-A
ambientes corporativos
REVENDEDOR
EXCLUSIVO
POLO MOVELEIRO
SILVIANO BRANDÃO

Cavaletti®
CADEIRAS PROFissionais

Cavaletti Flip

Dinamismo e agilidade são qualidades comuns aos ambientes corporativos contemporâneos. A Cavaletti desenvolveu a linha Flip para atender às exigências de versatilidade e qualidade ergonômica nos mais variados tipos de uso.

CARACTERÍSTICAS



MECANISMOS
Sistema Reclinador do Encosto (SRE), com regulagem de altura do encosto para modelo Executiva Giratória.



BRAÇOS
Opção de composição em todos os braços Cavaletti (exceto ID).



ASSENTO
Assento em espuma injetada, com regulagem de altura à gás.



BASES
Opção de bases em Aço com capa Nylon e Alumínio. Rodízios 50mm ou 65 mm, em Nylon ou PU.



ESPALDAR
Estrutura em plástico injetado de alta resistência. Disponível na cor Preto.



TELA
Membrana que se adapta à curvatura da coluna, proporcionando suporte e ventilação constantes. Disponível nas cores Preto e Cinza.



REVESTIMENTOS
Revestimentos disponíveis em Poliéster, Polítex, Mescla, Vinil, CEC, Space.



ESTRUTURAS
Estrutura S Fixa, com ou sem braços. Estrutura Z fixa ou com rodízios e Braços Integrados. Acabamento Cromado ou Pintura em Preto Microtexturizado.

CONFIGURAÇÕES



43.103 SRE
Executiva Giratória
Sistema Reclinador de Encosto (SRE)
Braços TC
Base Nylon
Rodízios 65mm



43.106 S
Executiva Aproximação
Estrutura S
Braços Loop



43.106 SI
Executiva Aproximação
Estrutura SI
Braços Integrados



43.106 Z
Executiva Aproximação
Estrutura Z
Braços Integrados



43.106 Z ROD
Executiva Aproximação
Estrutura Z com rodízios 50mm
Braços Integrados



43.122
Stool
Encosto Fixo
Braços TC
Base Nylon com sapatas (Polaina Opcional)
*Sistema Reclinador de Encosto (SRE) Opcional



43.110
Executiva Longarina
Braços Loop Intercalado
Estrutura Pé Preto ou Cromado
*A travessa é disponível apenas em Preto
**Não disponível com os Braços TC

TELAS

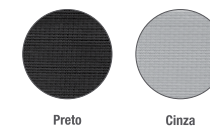

Preto

Cinza

DESENHOS TÉCNICOS

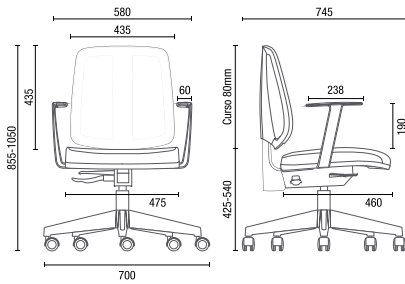

43.103 SRE Executiva Giratória

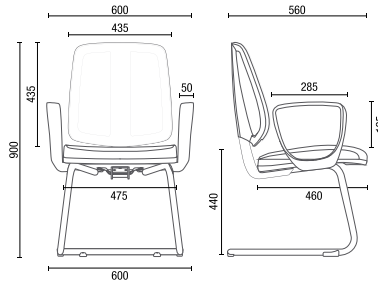

43.106 S Executiva Aproximação

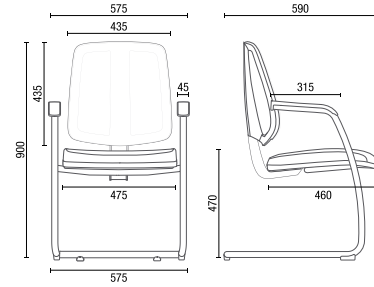

43.106 SI Executiva Aproximação

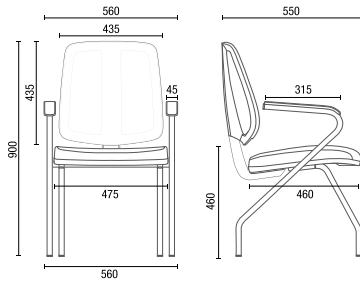

43.106 Z Executiva Aproximação

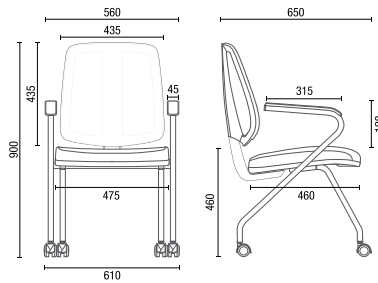

43.106 Z ROD Executiva Aproximação

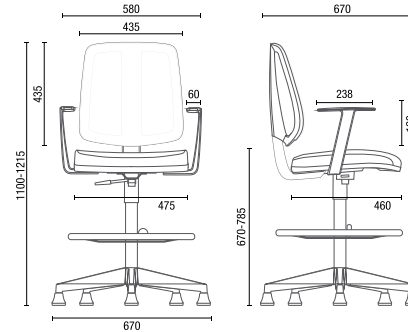

43.122 Stool

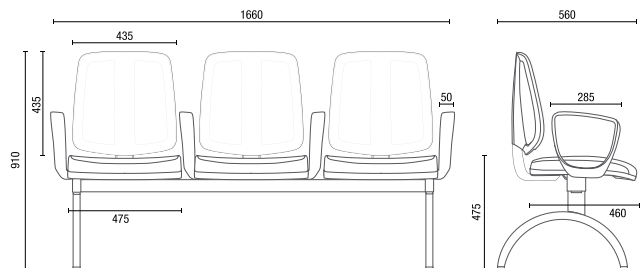

43.110 Executiva Longarina

OBS: Medidas extremas obtidas sem o uso de gabarito de carga.





Office-A[®]
ambientes corporativos

REVENDEDOR
EXCLUSIVO

POLO MOVELEIRO
SILVIANO BRANDÃO



CADEIRAS PROFISSIONAIS

Cavaletti FLIP LIGHT





FLIP LIGHT

A Cavaletti reuniu os seus consagrados produtos em uma linha que busca soluções otimizadas para as atividades profissionais e produtivas.

Os modelos contemplam configurações essenciais e na medida das necessidades atuais. O resultado, uma seleção capaz de ampliar conforto e bem-estar com toda a qualidade reconhecida.

Tem sempre uma Cavaletti para atender a sua necessidade.



CARACTERÍSTICAS

Braço SL New PP.

Ajuste de altura à gás.

Tela NewNet.

Tela preta, cinza, azul, vermelha ou marrom.

Encosto fixo.

Assento com espuma Injetada.

Revestimento em poliéster.

Aranha de aço com capa.

Rodízio de nylon (Opcional PU).



OBS: Tela preta (162), estrutura preta,
assento chumbo (044) e rodízio em nylon.

Cadeira Giratória Operacional: Tipo D
NBR 13.962-2018

FLIP LIGHT



43.503



43.503

REVESTIMENTOS



Poliéster
27 Cores



Tela NewNet
5 Cores



Office-A
ambientes corporativos

REVENDEDOR
EXCLUSIVO

POLO MOVELEIRO
SILVIANO BRANDÃO

Cavaletti®

CADEIRAS PROFISSIONAIS



Cavaletti PRO

Cavaletti Pro

Espaços de trabalho dinâmicos pedem assentos confortáveis, práticos e duráveis, que se integrem à arquitetura de cada ambiente. Criada para atender áreas operativas e gerenciais, a linha Pro oferece soluções para atender de forma inteligente uma grande variedade de usuários, com alto índice de conforto e funcionalidade.

CARACTERÍSTICAS



APOIO DE CABEÇA
Apoio de Cabeça com 4 posições de regulagem e 40 mm de curso. Com dimensões generosas, oferece maior suporte a região cervical.

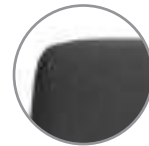

REVESTIMENTOS
Tecidos selecionados com costuras duplas nas opções: Poliéster, Space, Mescla, Politéx, Vinil, Haven, CEC ou Couro Natural.



MECANISMOS
Mecanismo Synchron ou Sistema Reclinador de Encosto (SRE), ambos com regulagem de altura do encosto, ou Relax.



BRAÇOS
Modelos giratórios com Braços Reguláveis SL, SL New PU ou 2D (todos com opção de Regulagem Lateral) ou 3D. Modelos fixos com Braços Integrados.

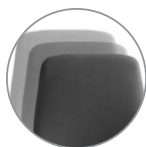

ESPALDAR
Espaldar com três opções de altura e com curvaturas anatômicas para maior suporte da coluna vertebral.



ASSENTO
Assento em espuma injetada com regulagem de altura à gás. Opção de regulagem de profundidade.



BASES
Bases em Alumínio, Nylon ou Aço com Capa. Rodízios em Nylon ou PU.



38001 L AC
Presidente Giratória
Synchron
Braço SL
Base Alumínio

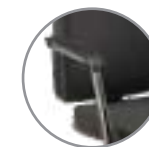

ESTRUTURA
Bases fixas na opção Balanço com ou sem Braços Integrados (S ou SI) e Sapata Estabilizadora. Acabamento Cromado ou Preto Microtexturizado.

CONFIGURAÇÕES



38001 L
Presidente Giratória
Synchron
Braço SL New PU
Base Aço com Capa



38001 SRE
Operacional Alta
Sistema Reclinador do Encosto
Braço SL
Base Aço com Capa



38003 SRE
Operacional Média
Sistema Reclinador do Encosto
Braço SL
Base Aço com Capa



38022 SRE
Stool
Sistema Reclinador do Encosto
Braço SL
Base Aço com Capa



38006 SI
Aproximação Alta
Estrutura SI
Braços Integrados



38006 S
Aproximação Alta
Estrutura S



38007 SI
Aproximação Média
Estrutura SI
Braços Integrados



38007 S
Aproximação Média
Estrutura S



38010
Longarina Média

DESENHOS TÉCNICOS

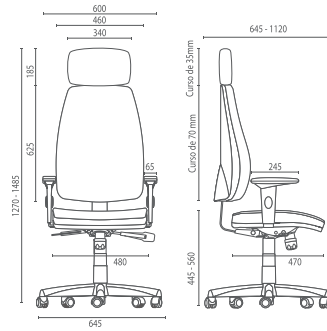

38001 AC Presidente Giratória

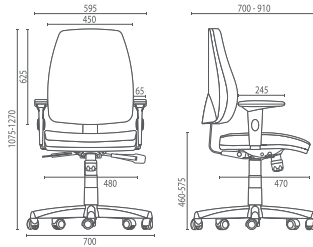

38001 L Presidente Giratória

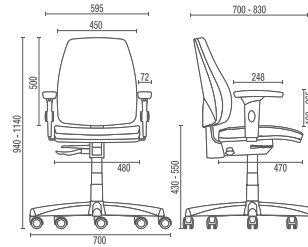

38001 SRE Operacional Alta

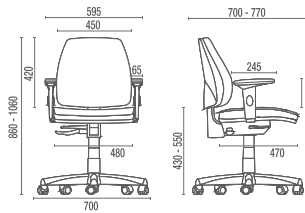

38003 SRE Operacional Média

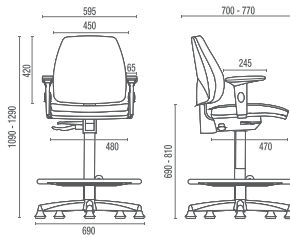

38022 SRE Caixa Média

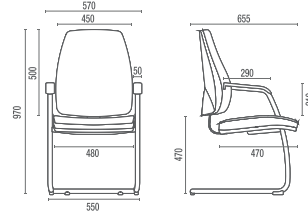

38006 SI Aproximação Alta com Braços Integrados

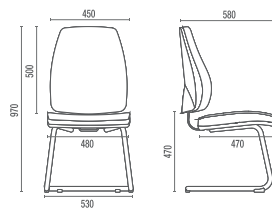

38006 S Aproximação Alta

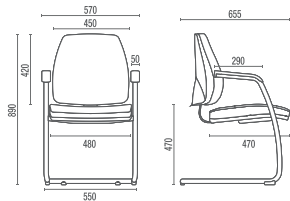

38007 SI Aproximação Média com Braços Integrados

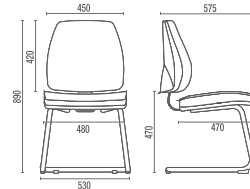

38007 S Aproximação Média

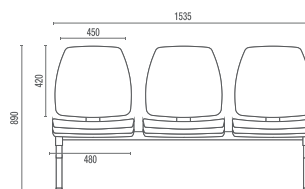

38010 Longarina Média
Larguras:
2L - 1010mm
4L - 2070mm
5L - 2600mm

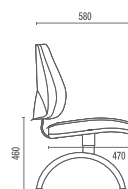

Office-A
ambientes corporativos

REVENDEDOR
EXCLUSIVO

POLO MOVELEIRO
SILVIANO BRANDÃO

Cavaletti
CADEIRAS PROFISSIONAIS



Cavaletti Viva



Cavaletti Viva

Inspirada na natureza, a linha Viva traz tonalidades exclusivas para serem combinadas com diversas configurações, adaptando-se a qualquer ambiente. Além da variedade de cores, os produtos apresentam design Cavaletti, exclusivo e mais ergonômico.

Aproveite, imagine, crie. Viva!



VERSÕES

VIVA

Os modelos da linha Viva possuem o Pega-Mão, que facilita o seu manuseio e transporte. Disponível em quinze tonalidades diferentes.

VIVA SPM

A versão Viva SPM traz a cadeira Viva sem o Pega-Mão em quatro opções de cores: Azul, Vermelho, Branco e Preto. Disponível para todas as configurações.

CORES

VIVA

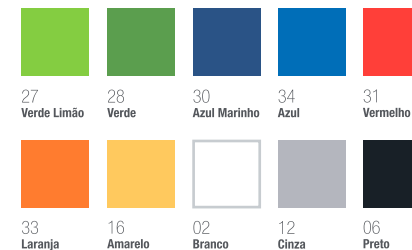

VIVA SPM

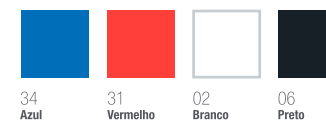

Disponível em cor personalizada para pedidos a partir de 500 unidades.

ESTRUTURAS

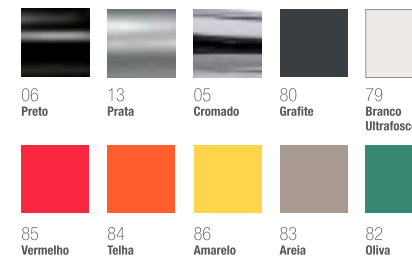

Acabamentos, ponteiros e o centro da longarina sempre serão na cor preta.

Ambientes de aprendizagem projetados para inspirar. A cadeira Viva com prancheta 360° possibilita fácil acesso e mobilidade, pois permite ser utilizada no lado esquerdo ou direito, na posição longitudinal, horizontal ou inclinada. Ideal para reajustes de layout, visando promover a interação entre participantes em atividades de aprendizado de maneira ativa e em grupo, com paleta de cores exclusivas para personificar os ambientes coletivos.



35004 Prancheta 360°

CONFIGURAÇÕES



35008 P
Aproximação Empilhável
Estrutura Palito



35008 P
Aproximação Empilhável
Empilhamento máximo:
10 unidades



35007 P
Aproximação
Estrutura Palito



35007 SE
Aproximação
Estrutura Balança
Assento Estofado
Disponível com Assento
Plástico sem Estofamento



35008 A
Aproximação Empilhável
Estrutura Arco
Empilhamento máximo:
05 unidades



35004
Giratória
Braço Z
Base Viva
Mecanismo Flange



35004 SL
Giratória
Braço SL
Base de Aço com Capa
Mecanismo Flange



35008 PU
Universitária
Estrutura Palito com Grade
Prancheta Removível



35007 Z
Aproximação
Braços Integrados



35007 Z ROD
Aproximação com Rodízios
Braços Integrados



35010
Longarina



Mecanismo de União
Modelos 35007 Z



Estofamento
Opção de assento e/ou encosto
estofados. Disponível para todos
os modelos.



35008 PUE
Universitária
Opção de Prancheta
Escamoteável

DESENHOS TÉCNICOS

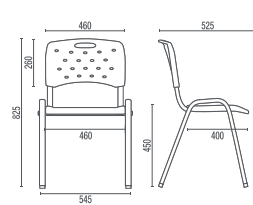

35008 P Aproximação Empilhável

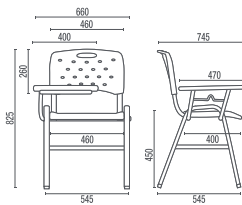

35008 PU Universitária

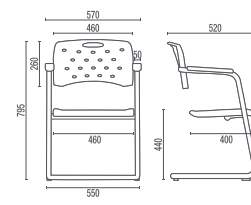

35007 S Aproximação

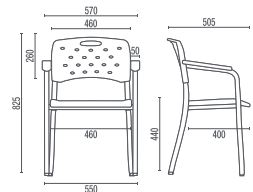

35007 P Aproximação

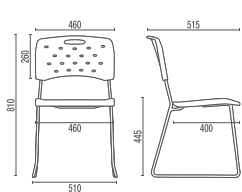

35008 A Aproximação Empilhável

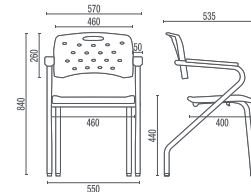

35007 Z / Aproximação

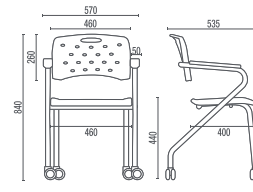

35007 Z ROD Aproximação com Rodízios

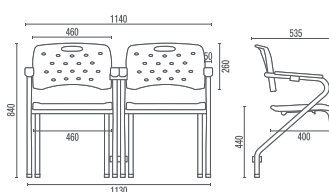

35007 Z Aproximação com Mecanismo de União

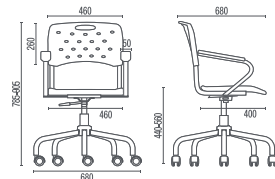

35004 Giratória Base Viva

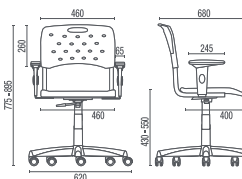

35004 Giratória Base em Aço com Capa

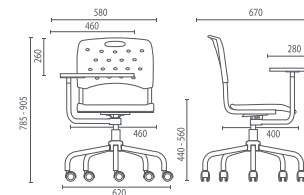

35004 Prancheta 360°

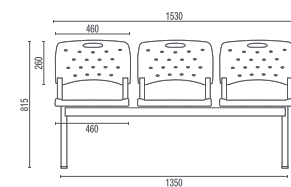

35010 Longarina
Larguras sem Braço:
2L - 1026mm 3L - 1530mm
4L - 2052mm 5L - 2578mm



Office-A
ambientes corporativos

REVENDEDOR
EXCLUSIVO

POLO MOVELEIRO
SILVIANO BRANDÃO



CADEIRAS PROFISSIONAIS

Cavaletti Essence



Office-A
ambientes corporativos

REVENDEDOR
EXCLUSIVO

POLO MOVELEIRO
SILVIANO BRANDÃO

Cavaletti[®]
CADEIRAS PROFISSIONAIS



Cavaletti Essence

Em um ambiente diretivo, essencial é reunir em um único produto, acabamentos refinados, dimensões generosas e ajustes ergonômicos para garantir amplo conforto em todas as decisões do dia.

CARACTERÍSTICAS



ESPALDAR
Espaldar com 770mm nos modelos Presidente. Maior dimensão entre os produtos Cavaletti.



MECANISMOS
Mecanismo Synchron de 4 estágios com regulação de tensão por manipulo central.

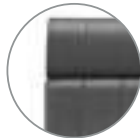

REVESTIMENTOS
Disponível em CEC ou 100% Couro Natural (COU).



BRAÇOS
Braços exclusivos, fixos em alumínio ou 4D em Nylon (Regulagem em altura, profundidade, afastamento lateral e rotação do apoio). Pad em PU Soft touch.



SUPORTE
Assento com três densidades de espuma, distribuídas conforme a área de apoio.

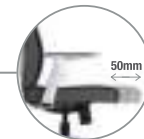

ASSENTO
Assento com Regulagem de Profundidade e Regulagem de Altura à Gás.



BASES
Opção de bases em Alumínio ou Nylon. Rodízios de 65mm em Nylon ou PU.



ESTRUTURAS
Base fixa com rodízios frontais para melhor movimentação. Acabamento cromado ou ultrafosco microtexturizado.

CONFIGURAÇÕES



20.501
Presidente Giratória
Synchron RP
Braços fixos em Alumínio
Base Alumínio



20.502
Diretor Giratória
Synchron RP
Braços fixos em Alumínio
Base Alumínio



20.506 S
Diretor Aproximação
Estruturas com rodízios frontais
Braços fixos em Alumínio

Mobilidade
Rodízios frontais



20.501
Presidente Giratória
Synchron RP
Braços 4D
Base Nylon



20.502
Diretor Giratória
Synchron RP
Braços 4D
Base Nylon



20.506 S
Diretor Aproximação
Estruturas com rodízios frontais
Braços 4D

REVESTIMENTOS

Couro Natural (COU)



Preto Branco

CEC



Preto Cinza Branco Bege Fendi

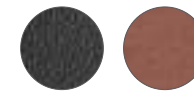

Marron Caramelo
NOVO



Vermelho Vinho Marron Verde Azul
NOVO NOVO

DESENHOS TÉCNICOS

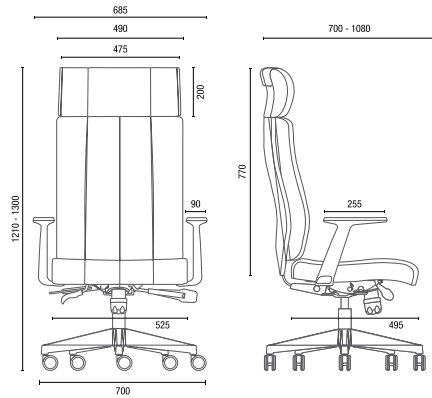

20.501 **Presidente Giratória**
Braços fixos em Alumínio

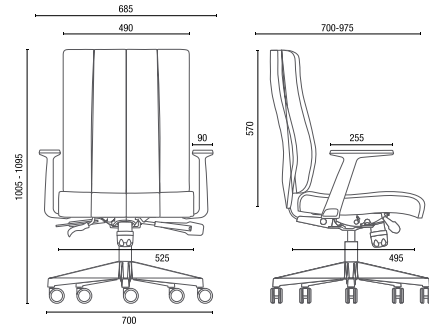

20.502 **Diretor Giratória**
Braços fixos em Alumínio

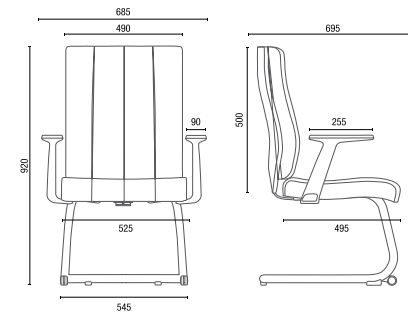

20.506 S **Diretor Aproximação**
Braços fixos em Alumínio

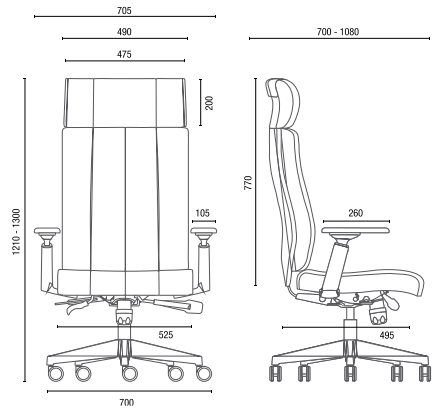

20.501 **Presidente Giratória**
Braços 4D

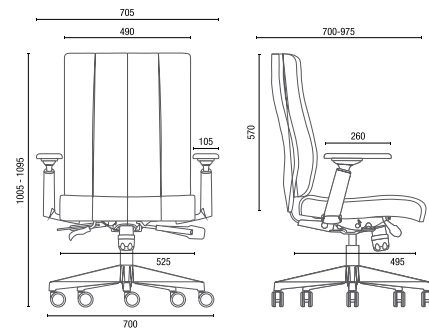

20.502 **Diretor Giratória**
Braços 4D

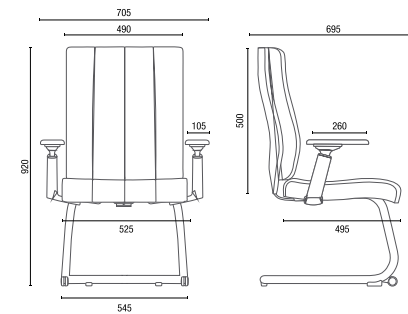

20.506 S **Diretor Aproximação**
Braços 4D



OBS: Medidas extremas obtidas sem o uso de gabarito de carga.



Office-A
ambientes corporativos

REVENDEDOR
EXCLUSIVO

POLO MOVELEIRO
SILVIANO BRANDÃO



CADEIRAS PROFISSIONAIS

Cavaletti Fun



Office-A
ambientes corporativos

REVENDEDOR
EXCLUSIVO

POLO MOVELEIRO
SILVIANO BRANDÃO

Cavaletti®
CADEIRAS PROFSSIONAIS



Cavaletti Fun

A linha Fun é direcionada a ambientes informais, nos quais um mobiliário leve e de linhas básicas ajuda a compor espaços agradáveis para o convívio e descontração. São modelos variados, todos disponíveis em cores para criar uma atmosfera alegre ou relaxante.



14020
Banqueta
Assento em Madeira com Verniz



14020
Banqueta
Assento Estofado

Produtos nessa imagem: Banqueta em madeira envernizada com estrutura Telha (84) e Banqueta estofada em CEC Verde (315) com estrutura Oliva (82).

ESTRUTURAS

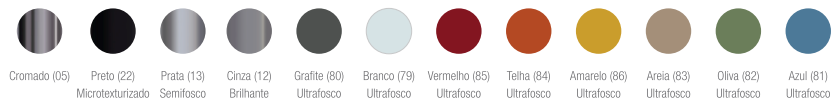

Produtos na imagem de ambientação: Banquetas em madeira envernizada com estrutura Telha (84) e CEC Verde (315) com estrutura Oliva (82). Puffs em Liv Jaspe (507), Liv Quartzo Rosa (509), Liv Arenito (500), Liv Turquesa (502), Liv Petróleo (505), Liv Carbono (504), Haven Céu (559), Haven Neve (555), Haven Laranja (553), Haven Terra (561) e Haven Asfalto (563). Spin em Haven Concreto (562). Stretch em Cec Azul (314) com estrutura Azul (81). Mesa Spin 36803 estrutura Areia (83).

CONFIGURAÇÕES



14015
Banqueta Alta
Com escosto
*Opcional com 50cm



14015
Banqueta Alta
*Opcional com 50cm



PUFF
Hexagonal Irregular
36.350 - Baixo 350mm
36.445 - Médio 450mm
36.475 - Alto 750mm



14016
Banqueta
Com escosto



14016
Banqueta
Sem escosto



PUFF
Hexagonal Regular
36.635 - Baixo 350mm
36.645 - Médio 450mm
36.675 - Alto 750mm



36016
Banco Giratório
Base em Alumínio



746
Revisteiro



747
Revisteiro



PUFF
Quadrado
36.030 - 450mm

Produtos nessa página: Banquetas em Cec Azul (314) com estrutura Azul (81), Cec Verde (315) com estrutura Branco (79), Cec Fendi (194) com estrutura Areia (83), Cec Cinza (175) com estrutura Preto Microtexturizado (22) e Cec Vinho (233) com base em Alumínio. Revisteiros em Vermelho (85) e Cinza (12). Puffs em Haven Areia (560), Haven Savana (557), Haven Terra (561), Liv Níquel (514), Liv Quartzo Rosa (509), Liv Turquesa (502) e Liv Safira (512).

DESENHOS TÉCNICOS

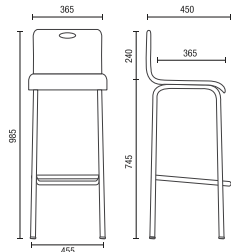

14020 Banqueta

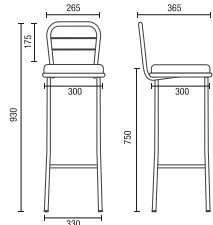

14015 Banqueta Alta com Encosto

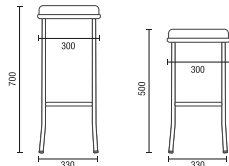

14015 Banqueta Alta / Baixa

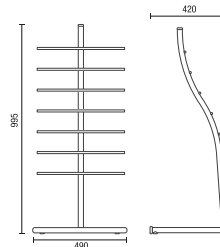

747 Revisteiro

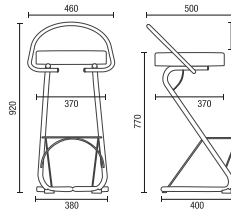

14016 Banqueta com Encosto

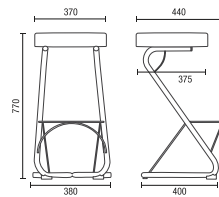

14016 Banqueta

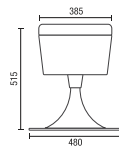

36016 Banco Giratório

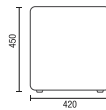

36030 Puff

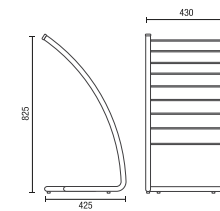

746 Revisteiro

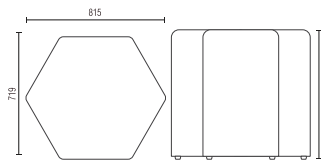

36675 Hexagonal Regular Alto 750mm

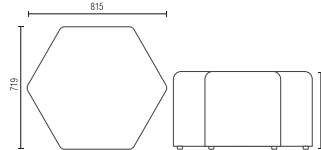

36645 Hexagonal Regular Médio 450mm

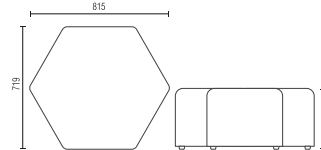

36635 Hexagonal Regular Baixo 350mm

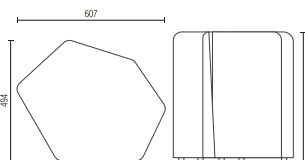

36475 Hexagonal Irregular Alto 750mm

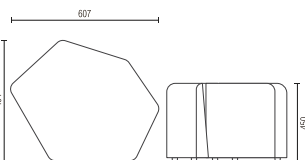

36445 Hexagonal Irregular Médio 450mm

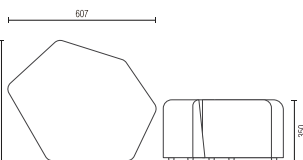

36350 Hexagonal Irregular Baixo 350mm



Seja Office
ou Home Office,
seja sempre
Office-A.



Para outros modelos, consulte também o nosso site
www.officea.com.br



Av. Silviano Brandão, 977 - Sagrada Família - BH/MG
(31) 2532.7777
www.officea.com.br



(31) 99775-6541